

CV-571-IR

HDMI extender over IP with IR and RS-232

User Manual



To avoid EMI issue, complete STP Cat6 cable is strongly recommended!



rev: 120403
Made in Taiwan



Safety and Notice

The **CV-57I-IR HDMI extender over IP with IR and RS-232** has been tested for conformance to safety regulations and requirements, and has been certified for international use. However, like all electronic equipments, the **CV-57I-IR** should be used with care. Please read and follow the safety instructions to protect yourself from possible injury and to minimize the risk of damage to the unit.

- Follow all instructions and warnings marked on this unit.
- Do not attempt to service this unit yourself, except where explained in this manual.
- Provide proper ventilation and air circulation and do not use near water.
- Keep objects that might damage the device and assure that the placement of this unit is on a stable surface.
- Use only the power adapter and power cords and connection cables designed for this unit.
- Do not use liquid or aerosol cleaners to clean this unit. Always unplug the power to the device before cleaning.



TABLE OF CONTENTS

INTRODUCTION	1
FEATURES.....	1
SPECIFICATIONS.....	2
PANEL DESCRIPTIONS.....	3
Transmitting unit ► CV-57I-IR-TX	3
Receiving unit ► CV-57I-IR-RX.....	4
PACKAGE CONTENTS	4
CONNECTION DIAGRAM	5
IR PASS-THROUGH.....	7
HARDWARE INSTALLATION.....	8
PIN DEFINITION	8
NOTICE	10
WARRANTY	11

INTRODUCTION

The **CV-57I-IR HDMI extender over IP with IR and RS-232** boosts up your video/audio transmission distance up to 100m (330ft) in HDTV 1080p format. With only one cost effective Cat.5/5e/6 cable, users can readily extend HDTV sources from DVD players, Blu-ray Disc player, PS3, PC, and any other kinds of sources compliant with TMDS to distant display monitors including HDMI or DVI enabled TV sets or LCD PC monitors. Besides **CV-57I-IR** also supports HDCP and this flexibility makes HDCP compliant DVD players or PS3 transmit utmost high quality video and audio with a greater distance at the minimal cost, when integrating several components apart. In addition, **CV-57I-IR** is also equipped with IR pass-through path and RS-232 serial port control.

The CV-57I-IR is also a HD video distribution solution for digital signage. With SP-5022I, CV-57I-IR can also support s a 10 layer “daisy-chain” for up to 1000M or even longer.

FEATURES

- Support HDMI 1.3
- DVI 1.0 Compliant
- Resolution up to 1080p or WUXGA (1920x1200) with 7.1 ch Audio
- Extends up to 100m(330ft) of output Cat.X solid UTP cable under Full HD (1080P)
- Supports full frequency IR signal from 20KHz to 60KHz
- IR pass-through path
- RS-232 Pass-Thru: Up to 115,200bps
- Wall mounting housing design for easy and robust installation

PACKAGE CONTENTS

- 1x CV-57I-IR [TX & RX]
- 1x IR blaster
- 1x IR receiver
- 2x DC 5V 2A wall wart
- 1x User Manual

SPECIFICATIONS

Model Name	CV-57I-IR	
Technical	CV-57I-IR[Tx]	CV-57I-IR[Rx]
Role of usage	Transmitter [TX]	Receiver [RX]
HDMI compliance	HDMI	
HDCP compliance	Yes	
Video bandwidth	Single-link 225MHz [6.75Gbps]	
Video support	480i / 480p / 720p / 1080i / 1080p60	
HDMI over UTP transmission [24-bit]	Full HD (1080p)-100m (330ft) [CAT.X]	
Audio support	Surround sound (up to 7.1ch) or stereo digital audio	
Signal Equalization	N/A	
Input TMDS signal	1.2 Volts [peak-to-peak]	
Input DDC signal	5 Volts [peak-to-peak, TTL]	
ESD protection	[1] Human body model — ±19kV [air-gap discharge] & ±12kV [contact discharge] [2] Core chipset — ±8kV	
PCB stack-up	4-layer board [impedance control — differential 100Ω; single 50Ω]	
IR pass-thru	Yes	
RS-232 support	Yes	
Input	1x HDMI + 1x 3.5mm	1x RJ45 + 1x 3.5mm
Output	1x RJ45 + 1x 3.5mm	1x HDMI + 1x 3.5mm
In/ Out	1x RS-232	1x RS-232
HDMI source control	Controllable via IR pass-through from RX to TX and from TX to RX with IR extenders	
IR remote control	Electro-optical characteristics: $\tau = 25^\circ$ / Carrier frequency: 20-60kHz	
HDMI connector	Type A [19-pin female]	
RJ45 connector	WE/SS 8P8C with 2 LED indicators	
3.5mm connector	IR blaster	IR receiver
Mechanical		
Housing	Metal enclosure	
Dimensions [L x W x H]	Model	TBA
	Package	TBA
	Carton	TBA
Weight	Model	TBA
	Package	TBA
Fixedness	Wall-mounting case with screws	
Power supply	5V 2A DC	
Power consumption	1.5 Watts	
Operation temperature	0~40°C [32~104°F]	
Storage temperature	-20~60°C [-4~140°F]	
Relative humidity	20~90% RH [no condensation]	

PANEL DESCRIPTIONS

Transmitting unit ► CV-57I-IR-TX

Front Panel

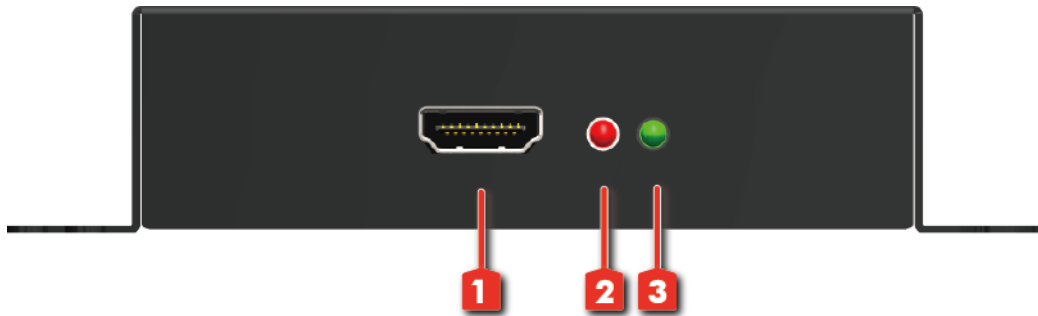

1. **HDMI IN:** Connects to a HDMI source with a HDMI male-male cable
2. **Power LED Indicator:** Power LED indicator
3. **Signal LED Indicator:** Signal LED indicator

Rear Panel

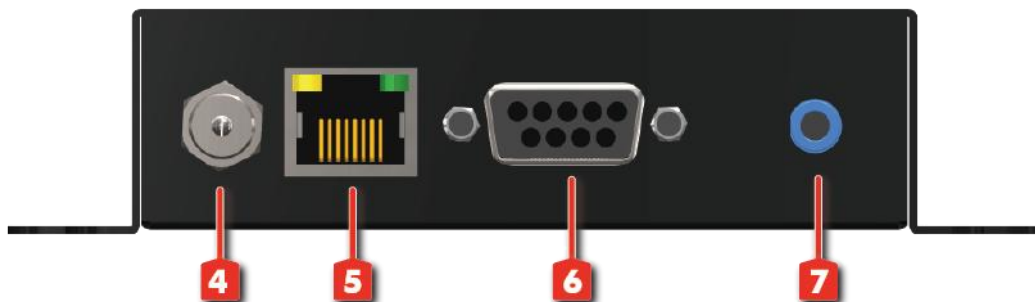

4. **+5V DC:** Connect to 5V DC power supply
5. **HDMI Signal OUT:** RJ-45 Network connector
6. **RS-232:** Connect to PC serial port with a DSUB-9 male-male cable here
7. **IR Blaster:** Infrared 3.5mm socket for plugging in the extension cable of IR blaster

Receiving unit ► CV-57I-IR-RX

Front Panel

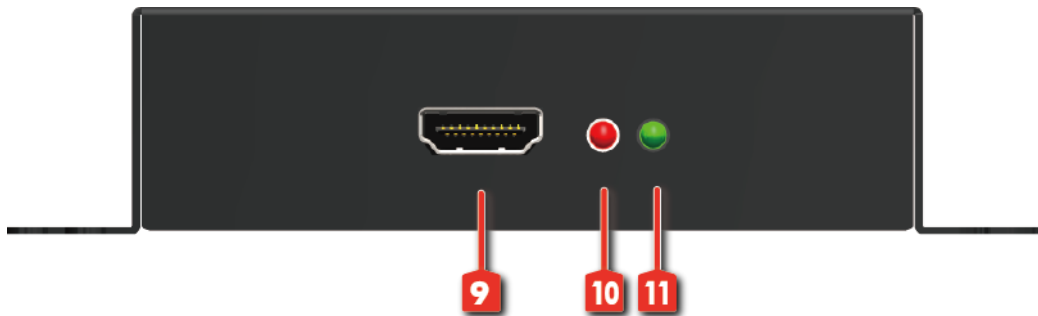

- 8. **HDMI OUT:** Connect to a HDMI display with a HDMI male-male cable.
- 9. **Power LED Indicator:** Power LED indicator
- 10. **Signal LED Indicator:** Signal LED indicator

Rear Panel

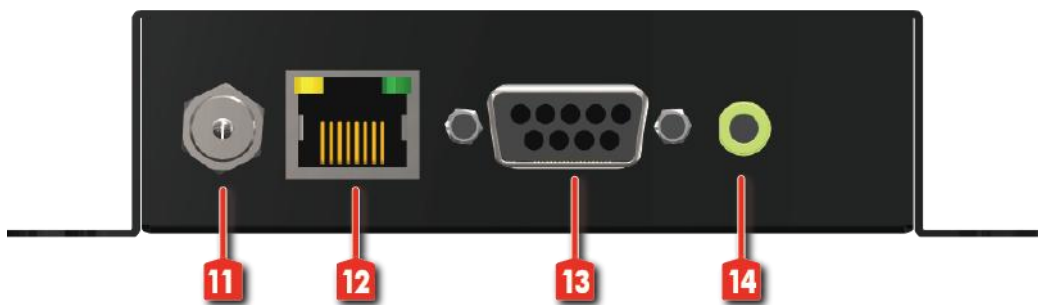

- 11. **+5V DC:** Connect to 5V DC power supply
- 12. **HDMI Signal IN:** RJ-45 Network connector
- 13. **RS-232:** Connect to PC serial port with a DSUB-9 male-male cable here
- 14. **IR Receiver:** Infrared 3.5mm socket for plugging in the extension cable of IR receiver

CONNECTION DIAGRAM

1 to 1

- HDMI
- IR (outgoing)
- CAT5/5e/6
- IR (incoming)

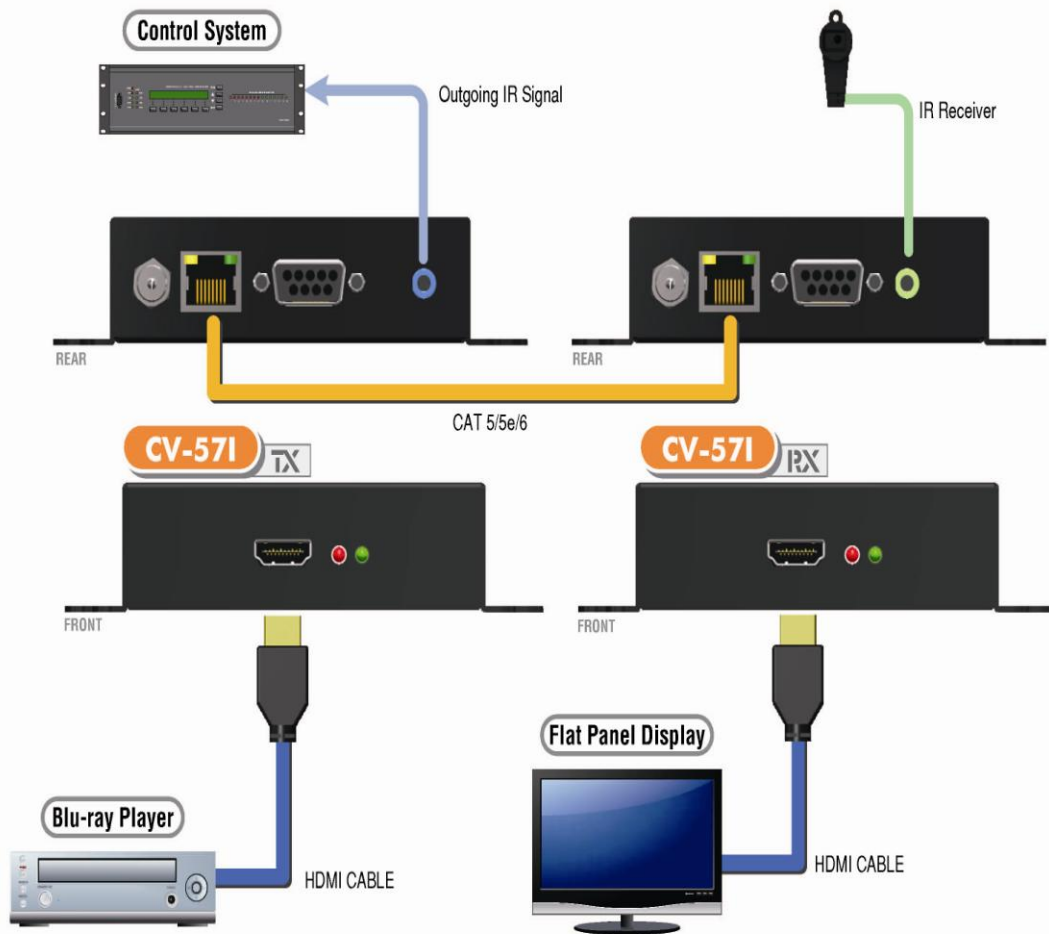

Cascading

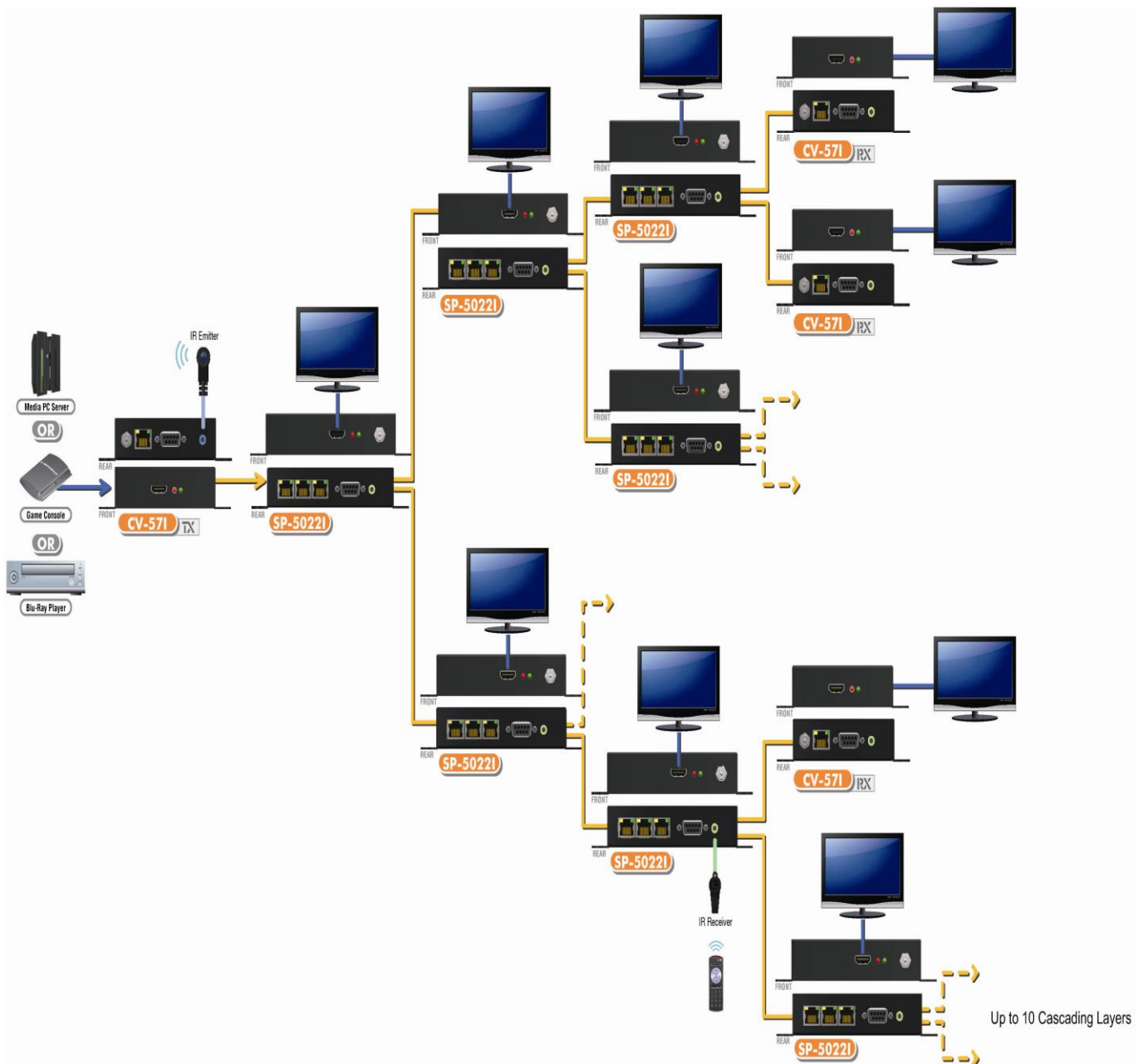

IR PASS-THROUGH

IR Extenders

IR Blaster



IR Receiver



IR Sockets

IR BLASTER: plug in the IR blaster to emit all IR command signals received from the IR receiver from the other end to control the devices corresponding to the IR signals.

IR RECEIVER: plug in the IR receiver to receive all IR command signals from the IR remote controls of the corresponding devices.

CAUTION!

Incorrect placement of IR Blaster and Receiver may result in the failure of the IR extenders. Please check carefully before plugging in the IR extender to the respective IR sockets. Warranty will not cover the damage.

Definition of IR Earphone Jack

IR Blaster



1. IR Signal
2. Grounding

IR Receiver

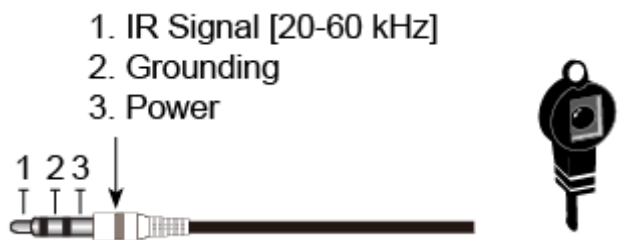

1. IR Signal [20-60 kHz]
2. Grounding
3. Power



You can buy any IR extension cables in the market that are compatible to the definition of the IR sockets for the matrix if necessary for replacement use. However, IR cables longer than 2m (6-ft) may not work.

HARDWARE INSTALLATION

1. Connect a HDMI or DVI source (such as a Blu-ray Disc player) to the transmitting unit CV-57I-IR-TX.
2. Connect a HDMI or DVI display (such as a LCD TV) to the receiving unit CV-57I-IR-RX.
3. Connect IR Blaster/Receiver to both TX and RX units.
4. Connect a Cat-5/5e/6 cable between the transmitting and receiving units.
5. Make sure this Cat-5/5e/6 cable is tightly connected and not loose.
6. Plug in 5V DC power supply unit to the power jack of the receiving unit CV-57I-IR-RX.
7. Plug in 5V DC power supply unit to the power jack of the transmitting unit CV-57I-IR-TX.
8. Power on source and display.

EDID LEARNING

1. Keep pushing receiver EDID button
2. Unplug and plug-in power to reboot receiver
3. Release EDID button till screen show OSD "EDID copy success"
4. Receiver will send display EDID to sender for ensuring correct video format output from video source

PIN DEFINITION



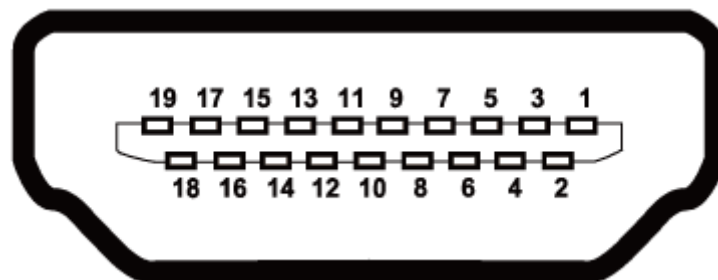





HDMI

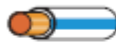

Type A (Receptacle) HDMI

Pin 1	TMDS Data2+	Pin 11	TMDS Clock Shield
Pin 2	TMDS Data2 Shield	Pin 12	TMDS Clock-
Pin 3	TMDS Data2-	Pin 13	CEC
Pin 4	TMDS Data1+	Pin 14	Reserved (N.C. on device)
Pin 5	TMDS Data1 Shield	Pin 15	SCL
Pin 6	TMDS Data1-	Pin 16	SDA
Pin 7	TMDS Data0+	Pin 17	DDC/CEC Ground
Pin 8	TMDS Data0 Shield	Pin 18	+5V Power
Pin 9	TMDS Data0-	Pin 19	Hot Plug Detect
Pin 10	TMDS Clock+		

CAT5 [RJ45]

Data Link TIA/EIA-568-B		
PIN	Color	Function
1	 W-O	TX0-
2	 O	TX0+
3	 W-G	TX1-
4	 BL	TX2-
5	 W-BL	TX2+
6	 G	TX1+
7	 W-BR	TXC-
8	 BR	TXC+

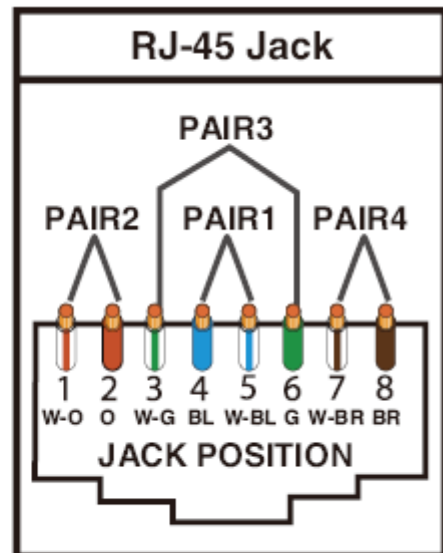

NOTICE

1. When adjusting the signal level on the receiver unit, please dial the rotary control switch from MIN to MAX and stop turning the rotary switch whenever the audio/video is playing normally. Inappropriate signal level setting may cause overpowering issue that would shorten the product life significantly!
2. Wrongly insert IR blaster and IR receiver to wrong 3.5mm infrared sockets may result in the failure of the IR extenders. Please check carefully before plugging in the IR extender to the respective IR sockets.
3. If the DVI or HDMI device requires the EDID information, please use EDID Reader/Writer to retrieve and provide DVI or HDMI display EDID information.
4. All HDMI over CAT5 transmission distances are measured using Belden 1583A CAT5e 125MHz UTP cable and ASTRODESIGN Video Signal Generator VG-859C & VG-870B.
5. The transmission length is largely affected by the type of Cat-5/5e/6 cables, the type of HDMI sources, and the type of HDMI display. The testing result shows solid UTP cables (usually in the form of 300m [1,000ft] bulk cables) can transmit a lot longer signals than stranded UTP cables (usually in the form of fixed length patch cords). Shielded STP cables are better suited than unshielded UTP cables. A solid UTP Cat-5e cable shows longer transmission range than stranded STP Cat-6 cable. For long extension applications, solid UTP/STP cables are the only viable choice.
6. EIA/TIA-568-B termination (T568B) for Cat-5/5e/6 cables is recommended for better performance.
7. To reduce the interference among the unshielded twisted pairs of wires in Cat-5/5e/6 cable, one can use shielded STP cables to improve EMI problems, which is worsen in long transmission.
8. Because the quality of the CAT5/6 cables has the major effect on how long the transmission limit can achieve and how good is the received picture quality, the actual transmission range is subject to one's choice of Cat-5/5e/6 cables. For desired resolutions greater than 1080i or 1280x1024, a Cat-6 cable is recommended.
9. If your HDMI display has multiple HDMI inputs, it is found that the first HDMI input [HDMI input #1] generally can produce better transmission performance among all HDMI inputs.



WARRANTY

The SELLER warrants the **CV-57I-IR HDMI extender over IP with bi-directional IR and RS-232** free from defects in the material and workmanship for 1 year from the date of purchase from the SELLER or an authorized dealer. Should this product fail to be in good working order within 1 year warranty period, The SELLER, at its option, repair or replace the unit, provided that the unit has not been subjected to accident, disaster, abuse or any unauthorized modifications including static discharge and power surge. This warranty is offered by the SELLER for its BUYER with direct transaction only. This warranty is void if the warranty seal on the metal housing is broken.

Unit that fails under conditions other than those covered will be repaired at the current price of parts and labor in effect at the time of repair. Such repairs are warranted for 90 days from the day of reshipment to the BUYER. If the unit is delivered by mail, customers agree to insure the unit or assume the risk of loss or damage in transit. Under no circumstances will a unit be accepted without a return authorization number.

The warranty is in lieu of all other warranties expressed or implied, including without limitations, any other implied warranty or fitness or merchantability for any particular purpose, all of which are expressly disclaimed.

Proof of sale may be required in order to claim warranty. Customers outside Taiwan are responsible for shipping charges to and from the SELLER. Cables and power adapters are limited to a 30 day warranty and must be free from any markings, scratches, and neatly coiled.

The content of this manual has been carefully checked and is believed to be accurate. However, The SELLER assumes no responsibility for any inaccuracies that may be contained in this manual. The SELLER will NOT be liable for direct, indirect, incidental, special, or consequential damages resulting from any defect or omission in this manual, even if advised of the possibility of such damages. Also, the technical information contained herein regarding the **CV-57I-IR** features and specifications is subject to change without further notice.