

SP-5004VZC

1x4 4K-HDR HDMI Splitter over Single Cat.X with HDBaseT-Lite, IR, RS-232, PoC & Loopout

User Manual



rev: 190314
Made in Taiwan



Safety and Notice

The **SP-5004VZC 1x4 4K-HDR HDMI Splitter over Single Cat.x with HDBaseT-Lite, IR, RS-232, PoC & Loopout** has been tested for conformance to safety regulations and requirements, and has been certified for international use. However, like all electronic equipments, the **SP-5004VZC** should be used with care. Please read and follow the safety instructions to protect yourself from possible injury and to minimize the risk of damage to the unit.

- Follow all instructions and warnings marked on this unit.
- Do not attempt to service this unit yourself, except where explained in this manual.
- Provide proper ventilation and air circulation and do not use near water.
- Keep objects that might damage the device and assure that the placement of this unit is on a stable surface.
- Use only the power adapter and power cords and connection cables designed for this unit.
- Do not use liquid or aerosol cleaners to clean this unit. Always unplug the power to the device before cleaning.



TABLE OF CONTENTS

INTRODUCTION	1
FEATURES	1
PACKAGE CONTENTS	2
SPECIFICATIONS	3
PANEL DESCRIPTIONS	4
IR PASS-THROUGH	5
CONNECTION DIAGRAM	6
NOTICE	7
WARRANTY	9

INTRODUCTION

The **SP-5004VZC 1x4 4K-HDR HDMI Splitter over Single Cat.x with HDBaseT-Lite, IR, RS-232, PoC & Loopout** provides the most cost effective and advanced HDMI splitter solution on the market, by which the high definition video and high quality audio can be transmitted up to 10* different locations without losing quality. SP-5004VZC supports all 3D formats, the true 4K 2K video and provides two HDMI local loopouts. In addition, SP-5004VZC is also equipped with bi-directional IR pass-through path and RS-232 serial port control.

With built-in USB firmware update mechanism, the compatibility among countless HDMI sources and receivers can be further guaranteed. With the upmost 12 bit deep color video and high definition audio support, SP-5004VZC is suitable for high quality HDMI broadcasting, digital signage and education applications!



It depends on receiver's outputs number.

FEATURES

- HDMI 2.0a compliant
- Supports 4K2K@60 4:4:4 8bits
- Supports HDR¹, which is 4K2K@60 4:2:0 10bits²
- Extends HDMI signal up to 60m (198ft) from the HDMI source at Full HD 1080p 36-bit, 35m (114ft) at 4K2K@60 444 (4K-HDR Technology)
- Supports PoC(Power over Cable) which can power from TX side with power supply
- Supports two HDMI loopouts
- HDCP 2.2/1.4 support
- Supports resolution downscaling from 4K2K to 1080P¹
- Supports EDID management
- Auto equalization
- Pure unaltered uncompressed 7.1ch digital HDMI over Cat.5/5e/6 cable transmission
- DTS-HD Master Audio and Dolby TrueHD high bit rate audio support
- Supports full frequency IR signal from 30KHz to 56KHz
- Bi-directional IR path-through
- RS-232 Pass-Thru: Up to 115,200bps
- Video latency less than 20 us.
- Easy installation



1. HDR = High Dynamic Range.
2. The video bandwidth of 4K2K@60 4:2:0 10bits (HDR) is 384 MHz, and the 4K2K@60 4:4:4 8bits is 594MHz.



1. When used in conjunction with the EX-57VAC-I-SP-RX receiver
 - (a) the SP-5004VZC can support resolution downscaling from 4K2K to 1080P
 - (b) NOT supports resolution downscaling from 4K2K@60 4:2:2 to 1080P
 - (c) NOT supports frame rate conversion

PACKAGE CONTENTS

- 1x SP-5004VZC
- 1x DC 12V 7.5A
- 1x IR receiver
- 1x IR blaster
- 1x User Manual
- 1x 3-pin Terminal Block Connector

Model Name		SP-5004VZC
Technical		
Role of usage	1x4 Distribution Amplifier (Splitter)	
HDMI compliance	HDMI 2.0a	
HDCP compliance	Yes	
Video bandwidth	Single-link 600MHz [18Gbps]	
Video support	HDR 4K2K@60 (4:2:0 10bits) / 4K2K@60 (4:4:4 8bits)	
Transmission over UTP cable	1080p@60 60m (198ft) [CAT5e] 4K2K@60 (4:4:4 8bit) 35m (114ft) [CAT5e]	
Audio support	Surround sound (up to 7.1ch) or stereo digital audio	
Input TMDS signal	1.2 Volts [peak-to-peak]	
Input DDC signal	5 Volts [peak-to-peak, TTL]	
ESD protection	Human body model — ±15kV [air-gap discharge] & ±8kV [contact discharge]	
PCB stack-up	4-layer board [impedance control — differential 100Ω; single 50Ω]	
Input	1x HDMI + 1x 3.5mm	
Output	2x HDMI + 4x RJ-45[HDBaseT] + 1x 3.5mm	
IN/ OUT	1x RS-232	
HDMI source control	Controllable via IR pass-through from RX to TX with IR extenders	
HDMI connector	Type A [19-pin female]	
RJ-45 connector	WE/SS 8P8C(Reverse Mode)	
Rotary switch	Yes	
3.5mm connector	IR receiver / IR blaster	
Mechanical		
Housing	Metal enclosure	
Dimensions [L x W x H]	Model	298 x 150 x 27mm [11.7" x 5.9" x 1"]
	Package	376 x 240 x 112mm [1'2" x 9.4" x 4.4"]
	Carton	590 x 510 x 405mm [1'9" x 1'7" x 1'3"]
Weight	Model	1342g [3lbs]
	Package	2097g [4.6lbs]
Fixedness	1RU rack-mounting case with ears	
Power supply	12V 7.5A DC	
Power consumption	55Watts [MAX]	
Operation temperature	0~40°C [32~104°F]	
Storage temperature	-20~60°C [-4~140°F]	
Relative humidity	20~90% RH [no condensation]	

Front Panel



- Power LED:** Power indicator
- Micro-USB:** For technical support only [firmware update]
- HDMI Signal LED:** From the left side to the right is Input, loopout1 and loopout2
- Link Receiver LED:** Link LED indicator 1-4
- HDMI Signal LED at Receiver:** Output signal LED indicator 1-4

Rear Panel



- +12V DC:** Connect to the +12V DC power supply unit

7. EDID Management Rotary control:

MODE 0	Ultra HD(4K2K@60) – 8/10/12bit 3D HDR video & 7.1ch audio
MODE 1	Ultra HD(4K2K@60) – 8/10/12bit 3D HDR video & 2ch audio
MODE 2	Ultra HD(4K2K@30)(4K2K@60 420) – 8/10/12bit 3D HDR video & 7.1ch audio
MODE 3	Ultra HD(4K2K@30)(4K2K@60 420) – 8/10/12bit 3D HDR video & 2ch audio
MODE 4	Full-HD(1080p@60) – 12bit 3D video & 7.1ch audio
MODE 5	Full HD(1080p@60) – 8bit 2D video & 2ch audio
MODE 6	Learning EDID from loopout #1
MODE 7	Auto EDID analysis learning mode

- RS-232(terminal block format):** The order of RS-232 pin are TX, RX, GND (from the left side to the right)
- IR Receiver:** Infrared 3.5mm socket for plugging in the extension cable of IR receiver
- IR Blaster:** Infrared 3.5mm socket for plugging in the extension cable of IR blaster
- HDMI IN:** Connect to a HDMI input source
- HDMI LOOPOUT #1:** Connect to a HDMI display with a HDMI male-male cable here

- 13. **HDMI LOOPOUT #2:** Connect to a HDMI display with a HDMI male-male cable here
- 14. **HDMI Signal OUT1-4:** Link to each HDMI display via a Cat-5/5e/6 cable with a HDMI over Cat.X receiver.

IR PASS-THROUGH

IR Extenders

IR Blaster



IR Receiver



IR Sockets

IR BLASTER: plug in the IR blaster to emit all IR command signals received from the IR receiver from the other end to control the devices corresponding to the IR signals.

IR RECEIVER: plug in the IR receiver to receive all IR command signals from the IR remote controls of the corresponding devices.

CAUTION!

Incorrect placement of IR Blaster and Receiver may result in the failure of the IR extenders. Please check carefully before plugging in the IR extender to the respective IR sockets. Warranty will not cover the damage.

Definition of IR Earphone Jack

IR Blaster

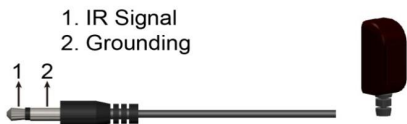

IR Receiver

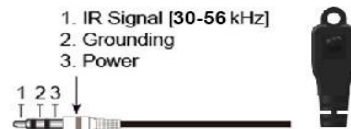

You can buy any IR extension cables in the market that are compatible to the definition of the IR sockets for the matrix if necessary for replacement use. However, IR cables longer than 2m (6-ft) may not work.

CONNECTION DIAGRAM

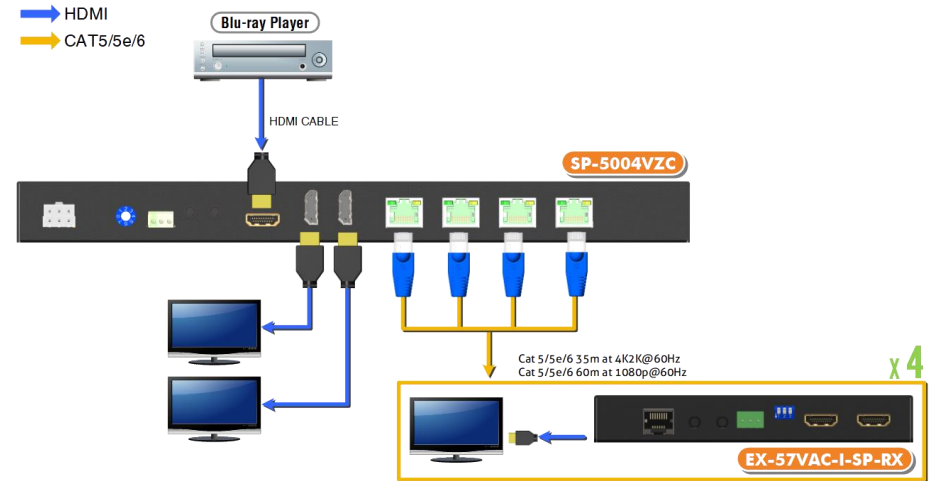



NOTICE

1. While connecting a new monitor to the splitter, experiencing a short period of time without display might be expected. The splitter will do Automatic EDID learning which analyzes the newly connected monitor to see if the EDID for the HDMI input is necessary to update!
2. Firmware update is proceed through Micro-USB

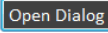
Main Board

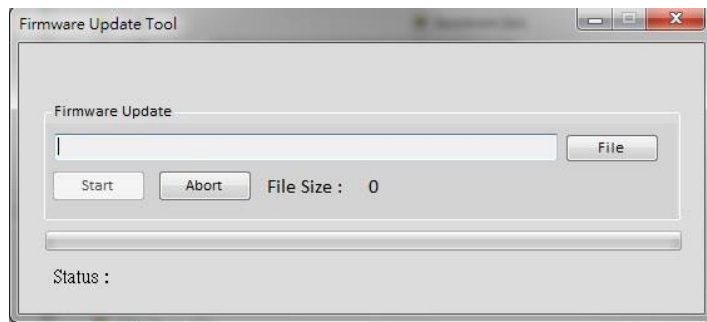
- (1) Power on the device
- (2) Connect the Micro-USB cable between PC and device
- (3) Open firmware update software
- (4) Set the correct COM port and **DO NOT** click  button
- (5) Click the  button to open the Firmware Update Tool window



- (6) Click the  button to select the main board firmware file
- (7) Click the  button and the firmware will start to update
- (8) After updating, please power cycle the device

Input

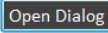
- (1) Power on the device
- (2) Connect the Micro-USB cable between PC and device
- (3) Open firmware update software
- (4) Set the correct COM port and click  button to connect software
- (5) Click the  button to open the software folder
- (6) Save the firmware file in this software folder and reconnect the Micro-USB cable
- (7) Open firmware update software and then device will start to update firmware automatically
- (8) After update process is done, software will show "Success" message and then be closed automatically
- (9) After updating, please power cycle the device

Output

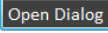
- (1) Power on the device
- (2) Connect the Micro-USB cable between PC and device
- (3) Open firmware update software
- (4) Set the correct COM port and click  button to connect software
- (5) Click the  button to open the FW Update window

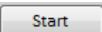

- (6) Click the  button to select the output firmware file
- (7) Click the  button and the firmware will start to update
- (8) After updating, please power cycle the device

WARRANTY

The SELLER warrants the **SP-5004VZC 1x4 4K-HDR HDMI Splitter over Single Cat.x with HDBaseT-Lite, IR, RS-232, PoC & Loopout** free from defects in the material and workmanship for 1 year from the date of purchase from the SELLER or an authorized dealer. Should this product fail to be in good working order within 1 year warranty period, The SELLER, at its option, repair or replace the unit, provided that the unit has not been subjected to accident, disaster, abuse or any unauthorized modifications including static discharge and power surge. This warranty is offered by the SELLER for its BUYER with direct transaction only. This warranty is void if the warranty seal on the metal housing is broken.

Unit that fails under conditions other than those covered will be repaired at the current price of parts and labor in effect at the time of repair. Such repairs are warranted for 90 days from the day of reshipment to the BUYER. If the unit is delivered by mail, customers agree to insure the unit or assume the risk of loss or damage in transit. Under no circumstances will a unit be accepted without a return authorization number.

The warranty is in lieu of all other warranties expressed or implied, including without limitations, any other implied warranty or fitness or merchantability for any particular purpose, all of which are expressly disclaimed.

Proof of sale may be required in order to claim warranty. Customers outside Taiwan are responsible for shipping charges to and from the SELLER. Cables and power adapters are limited to a 30 day warranty and must be free from any markings, scratches, and neatly coiled.

The content of this manual has been carefully checked and is believed to be accurate. However, The SELLER assumes no responsibility for any inaccuracies that may be contained in this manual. The SELLER will NOT be liable for direct, indirect, incidental, special, or consequential damages resulting from any defect or omission in this manual, even if advised of the possibility of such damages. **Also, the technical information contained herein regarding the SP-5004VZC features and specifications is subject to change without further notice.**